



White paper Blu-ray Disc Format

2.A Logical and Audio Visual Application Format Specifications for BD-RE

August 2004

INDEX

3. The Logical and Application for Blu-ray Disc Rewritable Specifications

3.1 Blu-ray Disc Rewritable Application Format

3.1.1 Overview

3.1.2 Recording of Digital Broadcasts

3.1.3 Support of Analog Broadcasts

3.1.3.1 Self-Encoded Stream Format (SESF)

3.1.3.2 Compatibility with MPEG-2 PS

3.1.4 Direct Recording of DV Input

3.1.4.1 Overview

3.1.4.2 DV Stream Recording Format

3.1.4.3 Random Access Method

3.1.4.4 Minimum Extent Size

3.1.5 User Interface

3.1.6 Editing

3.1.6.1 Seamless Connection Editing

3.1.6.2 Audio Dubbing

3.1.7 Blu-ray Disc File System (BDFS)

3.1.7.1 A File System Suited to Video/Audio Stream Recording

3.1.7.2 Continuous Data Supply by Extents

3.1.8 Copy Protection System (CPS)

3.1 Blu-ray Disc Rewritable Application Format

3.1.1 Overview

The Blu-ray Disc Rewritable (BD-RE) Application Format consists of: part2:File System Standard which defines the format for recording data to disc and the file management system; part3:Application Standard which defines the data structure of the file and the mechanism for stream management and user presentation; and part4:Content Protection System which defines copyright protection functions.

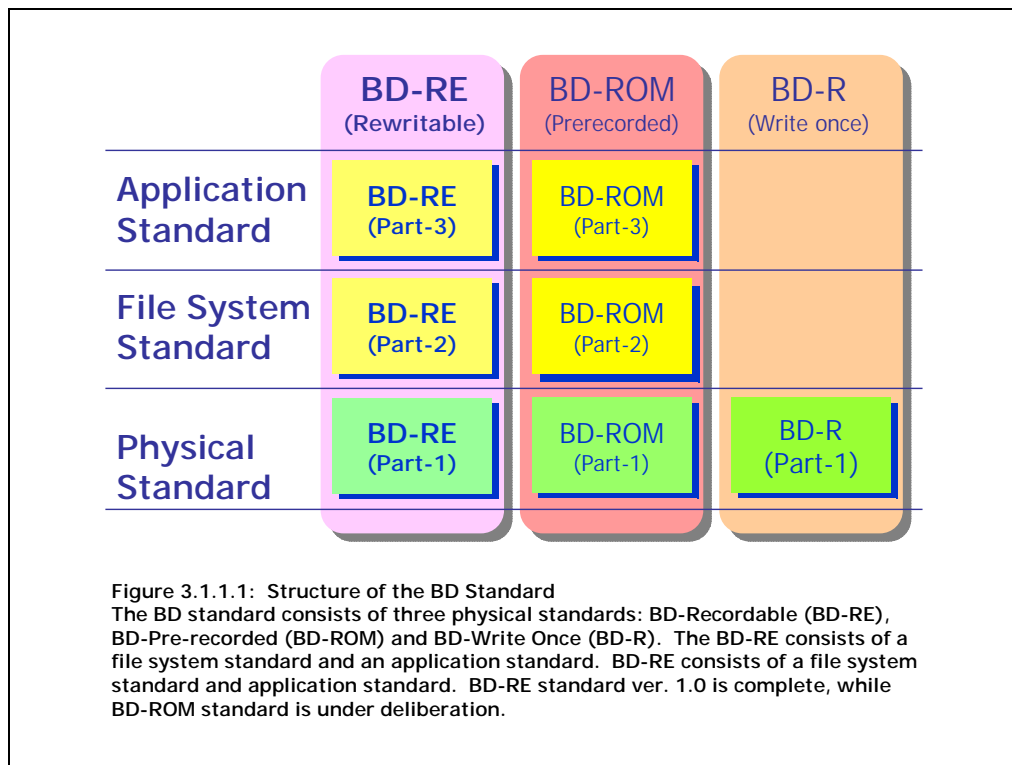

Since the commencement of BS digital broadcasting, digital Hi-Vision programs can be enjoyed on several channels in Japan. And when terrestrial broadcasting is digitalized in the near future, digital Hi-Vision broadcasting should spread to even more homes. The BD-RE Application Format takes advantage of characteristic disc features such as ease-of-use and ease-of-editing and enables BS digital and digital terrestrial broadcasts to be recorded and stored while maintaining the original picture quality. Making full use of the large capacity and high transfer rate of the BD-RE disc, the BD-RE Application Format has been designed to achieve the following:

- Recording of digital broadcasts including high-vision programming while maintaining the original picture quality—up to 2 hours on a single-layer disc and 4 hours on a dual-layer disc
- Long time recording of analog broadcasts such as standard definition (SD) programs (With a picture quality that is equivalent to that of VHS standard mode, approximately 12 hours can be recorded on a single-layer disc or approximately 24 hours on a dual-layer disc.)
- Seamless, non-destructive editing which takes advantage of disc features
- Direct recording of DV contents from the DV terminal of the camcorder with no picture deterioration (option)
- User interface that supports recorded content management in a visual manner
- Data allocation management which achieves seamless recording and playback of contents
- Content copyright protection and management by using copy protection technology

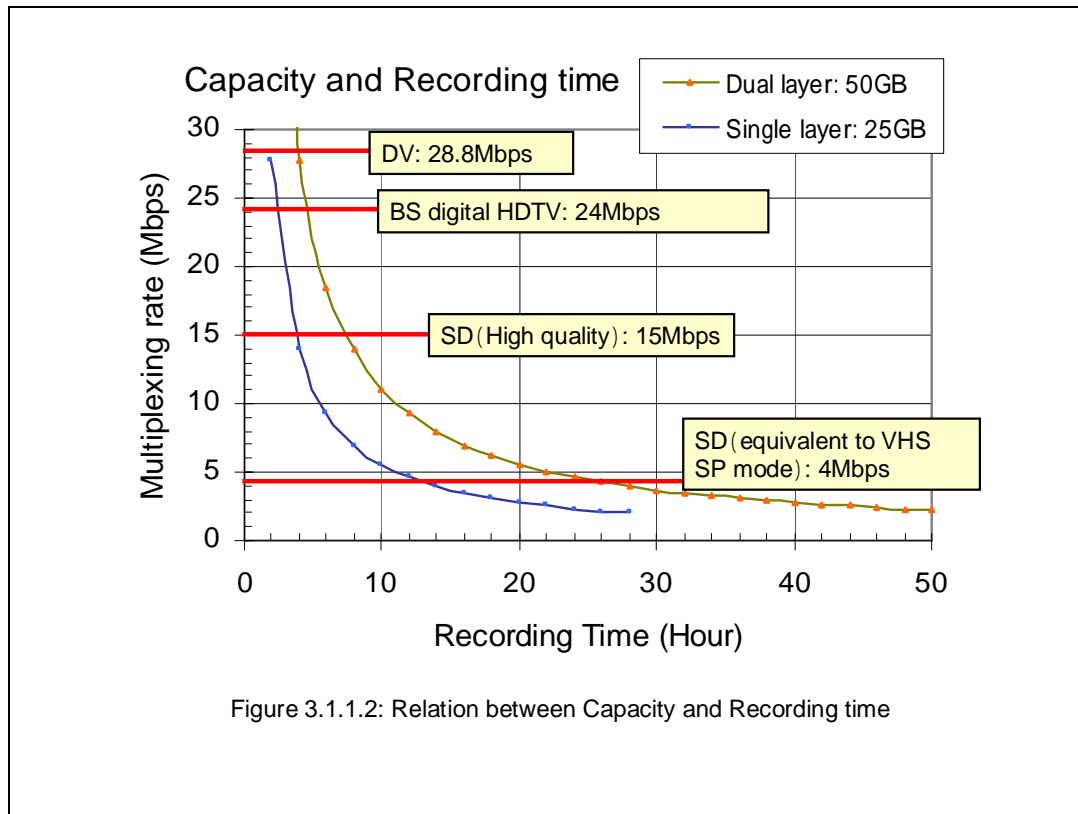

3.1.2 Recording of Digital Broadcasts

The characteristic of the recording format under the BD-RE Application Format is its adoption of MPEG-2 video for video codec and MPEG-2 TS (Transport Stream) for stream multiplexing.

DVD Video, on the other hand, employs MPEG-2 PS (Program Stream) as its multiplexing format. In comparison with MPEG-2 PS, MPEG-2 TS has a small packet size fixed at 188 bytes; it can multiplex multiple channels and EPG (Electronic Program Guide) information and is altogether more suited to broadcasting. The BD-RE Application Format enables transport streams of digital broadcasts to be recorded as they are without altering the format.

In current BS digital broadcasting systems, a single transponder is occupied by two or four transport streams and multiple programs (that is channels) are multiplexed in a single transport stream. A transport stream like this that is used for broadcasting and contains multiple programs is called a full transport stream (Fig. 3.1.2.1). On the other hand, a partial transport stream is made from the full transport stream by extracting the video/audio/data components of a particular program and reconfiguring the PSI/SI (Program Specific Information/Service Information), information which describes the programs.

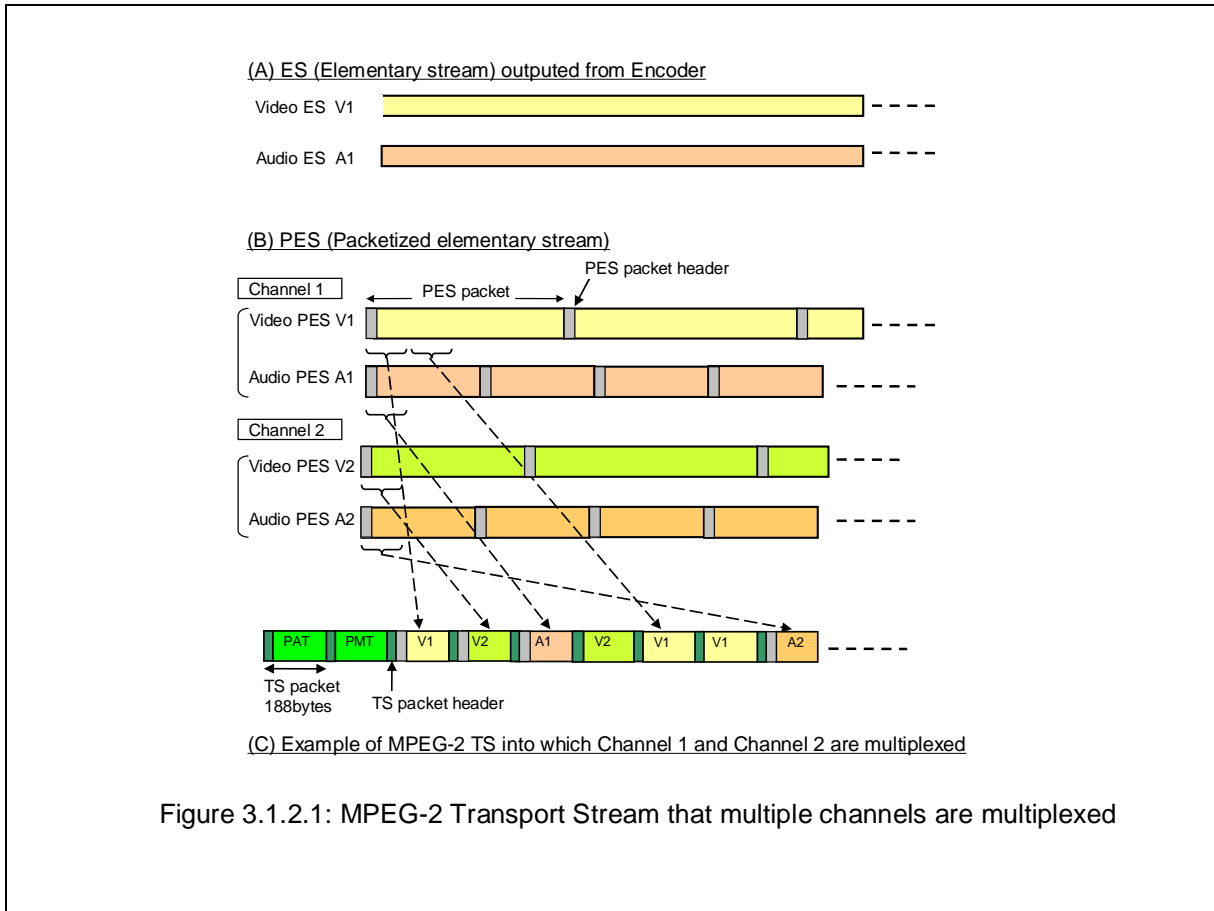

Figure 3.1.2.1: MPEG-2 Transport Stream that multiple channels are multiplexed

If a digital broadcast recorder were to record a full transport stream in its original form, the video/audio/data components of unwanted channels would also be recorded and use up the recording area. The conversion from full to partial transport stream is an important process for the recorder, as this process lowers the recording rate and allows the recording area to be used efficiently (Fig. 3.1.2.2).

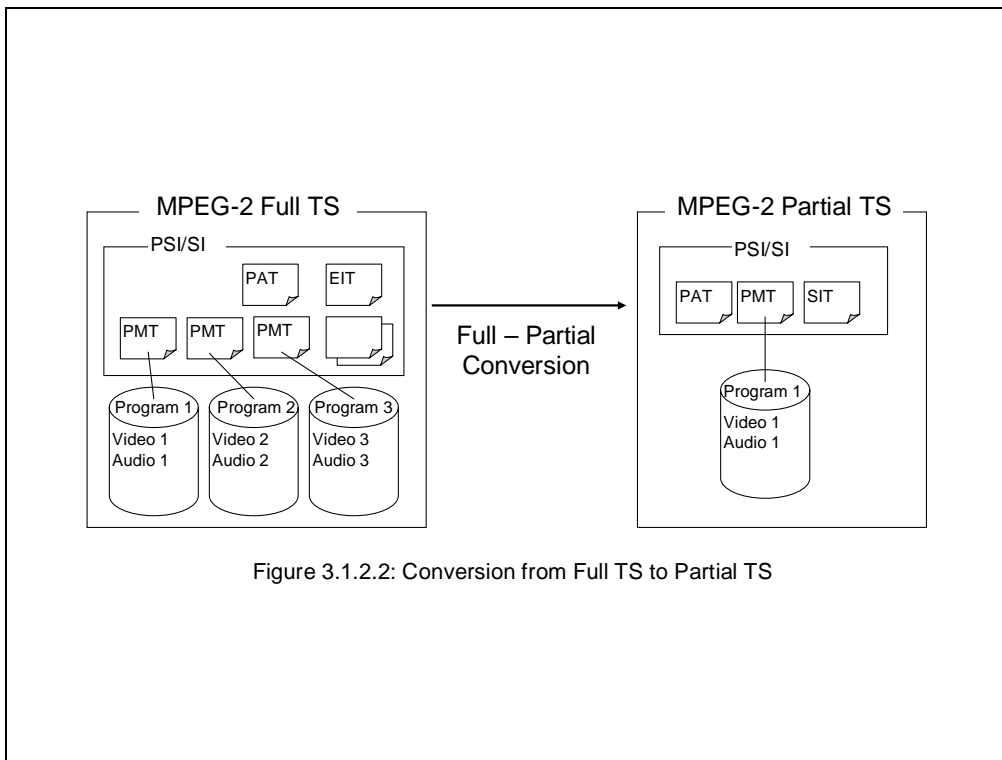
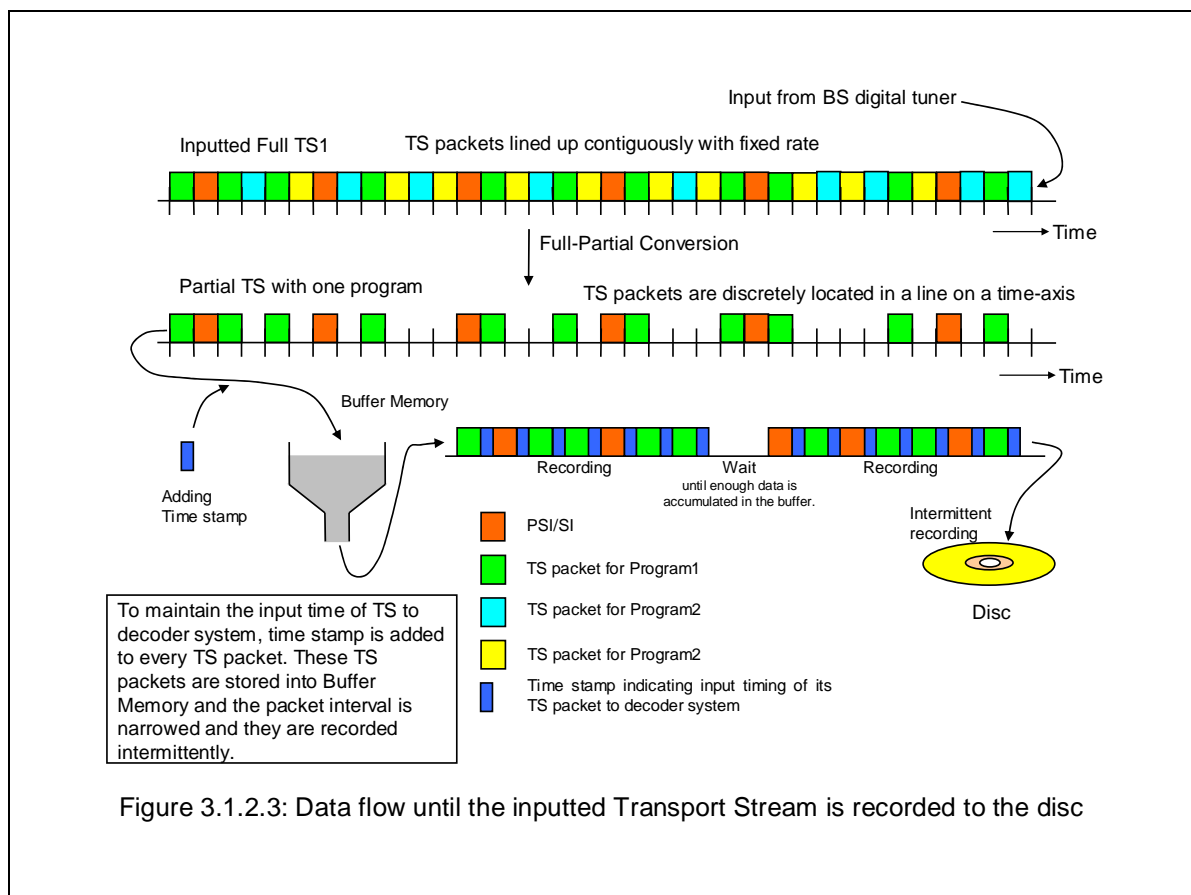
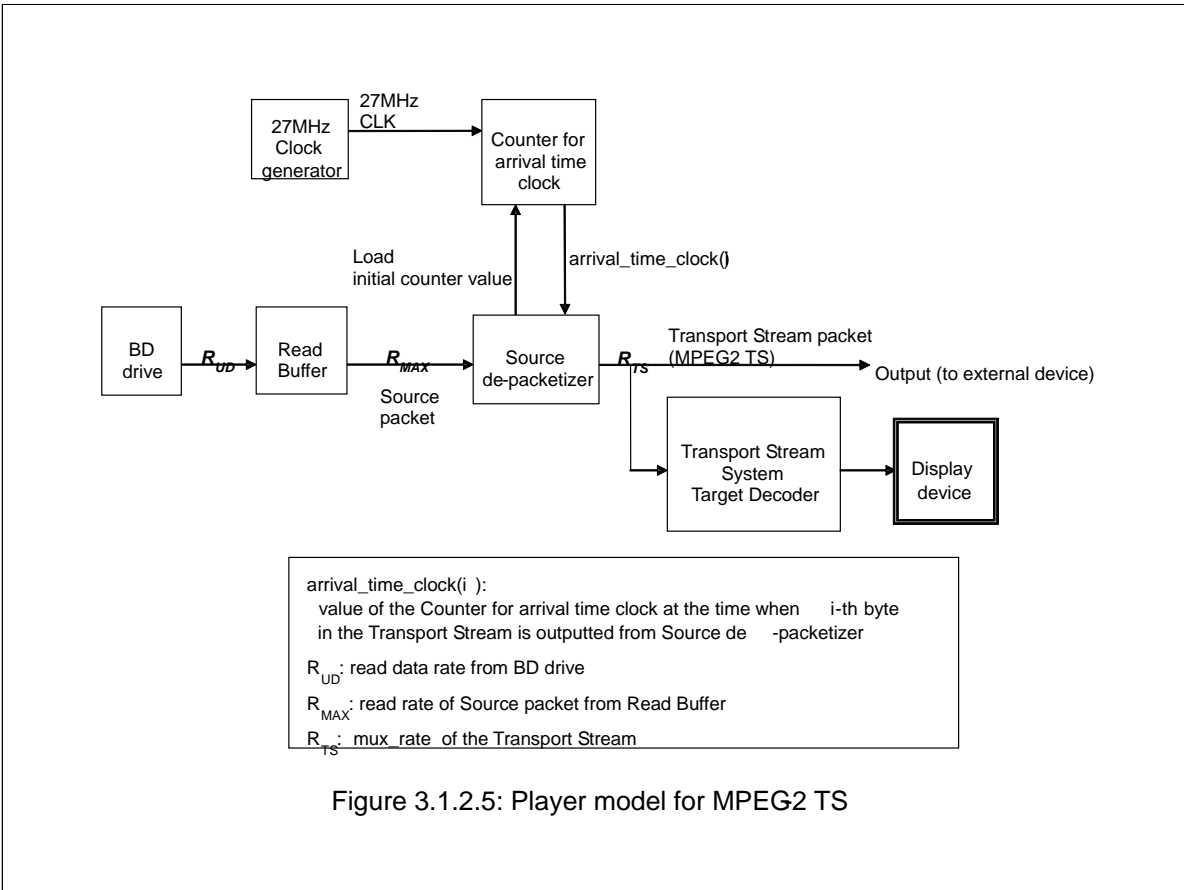
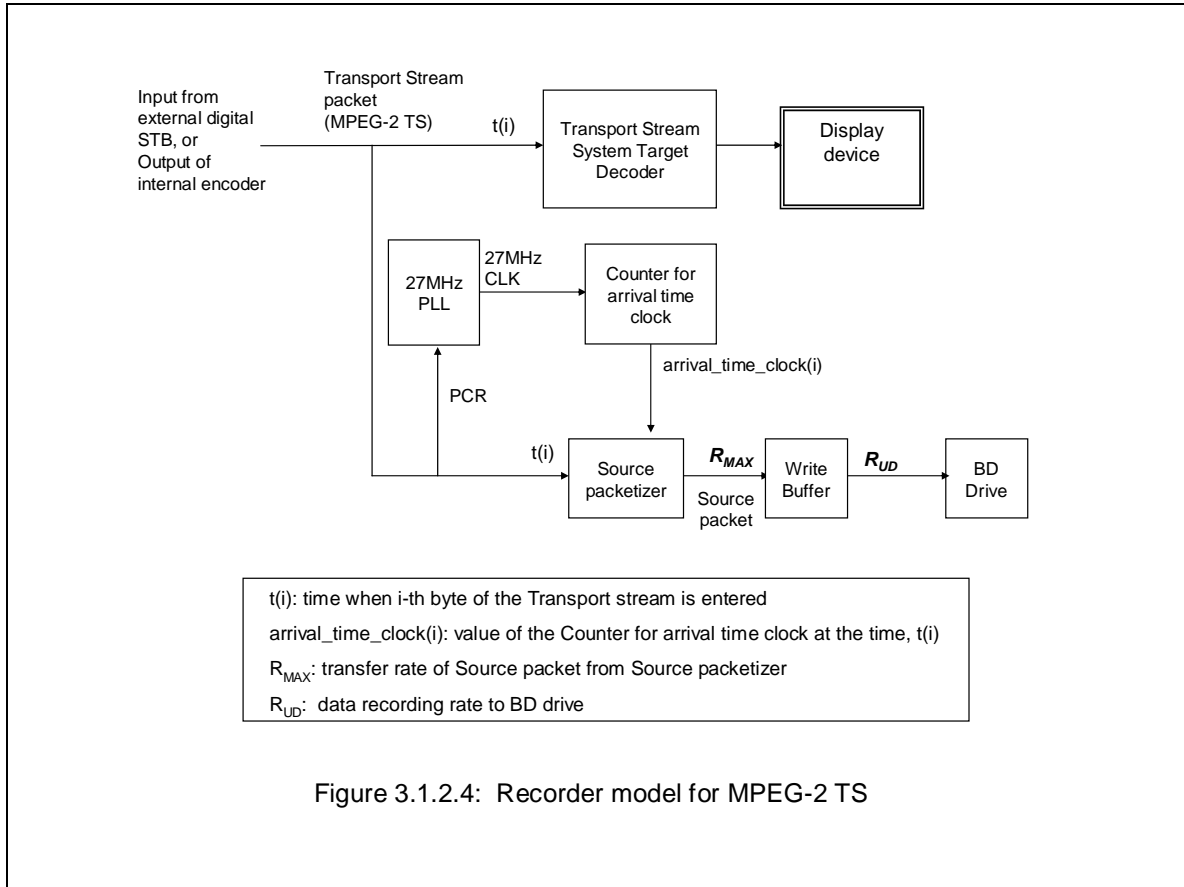

Figure 3.1.2.2: Conversion from Full TS to Partial TS

As shown in Fig. 3.1.2.3, in a partial transport stream which is reconstructed from the necessary packets extracted from the full transport stream, the time intervals between packets are not always the same. These packet intervals are determined by the buffer model and they must be observed when the packets are input to the demultiplexer/decoder or else the buffer will overflow or underflow and data will not be decoded correctly. For this reason, a header is added to each TS packet during recording to indicate the time that the TS packet arrived at the T-STD (Transport stream-System Target Decoder). Under the BD-RE Application Format, a TS packet attached with its packet arrival time is called a source packet. During playback, the packet intervals before recording are reproduced accurately based on the packet arrival times recorded in the source packet headers and the packets are then output to the T-STD or to outside the device (Fig. 3.1.2.4 and Fig. 3.1.2.5).





When recording a transport stream to disc, the information of other programs and other unwanted information are deleted from the PSI/SI and the information reconfigured and the recording is processed in accordance with copy control information; however, no changes are necessary at the coded data level (elementary stream) such as down-converting or re-encoding which affect picture and sound quality. This is how the BD-RE Application Format enables recording of Hi-Vision video, which can have a maximum bit rate of 24Mbps as shown in Fig. 3.1.2.6, and multi-channel audio while keeping the original broadcast quality.

	Profile and Level	Effective number of scanning lines	Horizontal pixel number	aspect ratio	bitrate
Video	MP@HL	1080i	1920, 1440	16:9	24Mbps max
	MP@HL	720p	1280	16:9	24Mbps max
	MP@H14L	480p	720	16:9	24Mbps max
	MP@ML	480i	720, 544, 480	16:9 or 4:3	15Mbps max
Audio	Coding	MPEG-2 AAC LC profile			
	Channel	5.1channel max			
	bitrate	Stereo		144kbps max	
		HiFi stereo (Compression mode B)		192kbps ~ 256kbps	
		Multi-channel		384kbps max	
fs	48kHz, (32kHz is possible for Digital Radio service)				

Figure 3.1.2.6: Video/Audio format of Japanese BS Digital Broadcast

The BD-RE Application Format also supports the recording of BS digital data broadcasts written in BML, a language that is based on XML. A data broadcast is made up of several files and consists of video/audio elements and a program that controls these elements. The files are segmented into sections, a format defined by MPEG-2 TS, and are transmitted repeatedly by the broadcast station in predetermined cycles (data carousel transmission). The receiver obtains one cycle of data beginning from a certain time and extracts the data in its internal memory to restore the files and execute the program. Because the timing of data multiplexing at the time of broadcast is retained under the BD-RE Application Format, the data broadcast is recorded in MPEG-2 TS format without being separated into files.

A convenient feature of digital broadcasting is EPG. The EPG is reconstructed from the PSI/SI multiplexed in the full transport stream: when recording to disc, the necessary information of recorded program is extracted from the PSI/SI and program information is reconstructed in a table called SIT and recorded. This makes it possible to view detailed program information even during playback.

The partial transport stream is also used as the multiplexing format for MPEG-2 streams that pass through i.LINK. Transport streams that are input to the BD-RE recorder from an external digital broadcast receiver via i.LINK can also be recorded without picture/audio deterioration.

In addition to digital broadcasting in Japan, there is DTV in America and DVB in Europe; partial transport stream recording is a highly adaptable recording format which can also be applied to these broadcasting systems.

3.1.3 Support of Analog Broadcasts

3.1.3.1 Self-Encoded Stream Format (SESF)

Although the BD-RE Application Format was designed for recording and playing back high-definition (HD) digital broadcasts, the format must also be capable of recording/playing analog broadcasts until all broadcasts make the transition to digital. Also, in response to demands for a format that enables users to dub video recorded on VTR and reuse streams that are encoded for DVD, a format for encoding analog input signals called SESF has been established.

SESF makes it possible to record/play current analog broadcasts efficiently in addition to HD digital broadcasts, and also guarantees compatibility between BD devices.

SESF conforms to the MPEG-2 TS systems standard (ISO/IEC 13818-1) and is limited to the streams that are required for encoding NTSC (or PAL) video input signals. Thus, the video stream of SESF can be decoded by standard MPEG decoders such as BS digital receivers.

As shown in Fig. 3.1.3.1.1, SESF recorded streams are defined as video, audio and teletext streams.

Video	MPEG-2 video
Audio	MPEG-1 audio Dolby AC-3 audio Linear PCM audio
Teletext	supported for PAL
Tip data	Tip TS

Figure 3.1.3.1.1: Elementary data of SESF

Video streams are encoded in MPEG-2 MP@ML format and recorded on a BD disc.

Video signals with the resolutions shown in Fig. 3.1.3.1.2 and Fig. 3.1.3.1.3 can be used and NTSC and PAL video signals are guaranteed to be recorded at sufficient resolutions. NTSC signals can be recorded at a maximum resolution of 720x480 pixels, which is equivalent to that of DVD packaged media.

720 x 480
704 x 480
544 x 480
480 x 480
352 x 480
352 x 240

Figure 3.1.3.1.2: Resolution under 525/60

720 x 576
704 x 576
544 x 576
480 x 576
352 x 576
352 x 288

Figure 3.1.3.1.3: Resolution under 625/50

SESF provides three types of recording formats for audio streams ranging from a low bit rate to high audio quality, as shown in Fig. 3.1.3.1.4.

CODEC	fs	bits per sample	channel	bitrate
MPEG-1 Layer 2	48 kHz		2 ch	32 kbps – 384 kbps
Dolby Digital	48 kHz		5.1 ch max	64 kbps – 448 kbps
LPCM	48 kHz	16, 20, 24 bits	2 ch	1.536 Mbps – 2.304 Mbps

Figure 3.1.3.1.4: Audio CODEC for SESF

The first audio format is MPEG-1 Layer-2, which is widely used in general consumer equipment (e.g. DTV

STB) and is suited to recording at comparatively low bit rates. The Dolby Digital (AC-3) format is the standard used in US satellite broadcasts and DVDs and allows relatively high-quality audio recording. In addition to these two formats, SESF provides a linear PCM format (optional) that supports 2-channel linear PCM recording of up to 48kHz, 24 bits for audio recording of even higher quality than that of existing CD and DVD recorders.

3.1.3.2 Compatibility with MPEG-2 PS

The stream recording format adopted by the BD-RE Application Format is based on MPEG-2 TS, the format used in digital broadcasts. However, some digital video recording devices such as DVD recorders use the MPEG-2 PS format, which is not directly compatible with the MPEG-2 TS format.

In order to achieve a higher level of compatibility with existing digital video recording devices and to utilize existing video sources, the BD-RE Application Format defines a method for transcoding from a program stream to a transport stream and vice versa. The stream used for this conversion is called the Constrained SESF.

The Constrained SESF handles 11 TS packets as a single unit called a multiplexing unit, shown in Fig. 3.1.3.2.1 A multiplexing unit holds up to 2048 bytes of valid data and can be converted to a program stream and recorded in a 2048-byte sector.

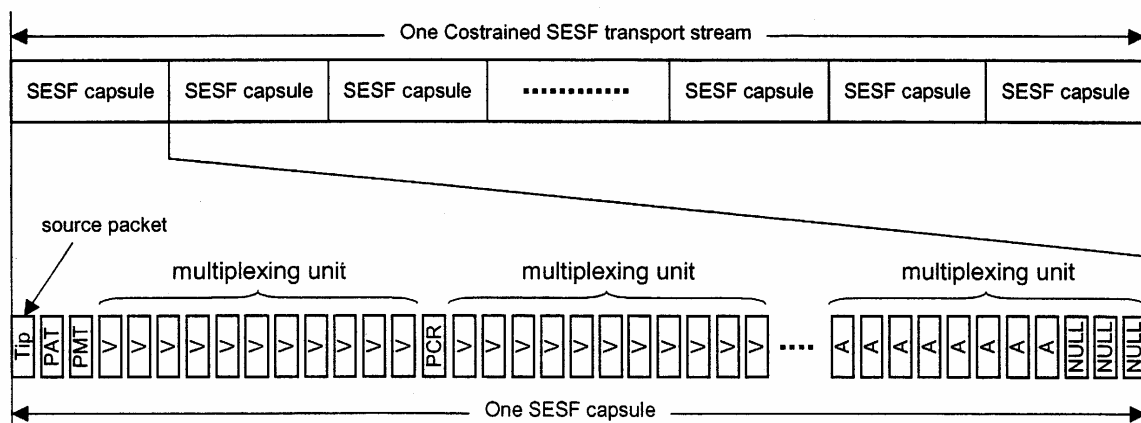

Figure 3.1.3.2.1: Stream of Constrained SESF

An SESF capsule is a grouping of video and audio data that consist of one or more GOPs (Group Of Pictures) and has been designed to enable playback and editing in units of SESF capsules. A Tip packet and PAT, PMT are inserted at the beginning of the SESF capsule.

The Tip packet contains display information such as the aspect ratio of the video data in the stream, CGMS such as the copy control information, and coding information such as the video resolution, and so on. All of this information makes it possible to quickly identify the decoding method before decoding the data.

During skip or high-speed playback, video data can be easily decoded by starting playback from the beginning of the SESF capsule.

As described above, not only does the BD-RE Application Format enable recording of high-resolution HD digital broadcasts but the format has been designed to support analog broadcast recording and the utilization of existing video sources. As a medium that records and plays all broadcasts, the BD-RE disc will enable a smooth transition from DVD and other existing recording media.

3.1.4 Direct Recording of DV Input

3.1.4.1 Overview

Taking advantage of the BD-RE drive's high user transfer rate (36Mbps), the BD-RE Application Format provides an optional functionality of recording DV streams (28.8Mbps) to BD-RE disc via the i.LINK. BD recorders that support this functionality enable users to record video material taken with a DV camcorder on BD-RE disc and take advantage of non-linear editing and other functions characteristic of disc media.

3.1.4.2 DV Stream Recording Format

The recording format for the DV stream conforms to the DVCR digital interface standard (IEC 61883-2) (Fig. 3.1.4.2.1). The DV stream received through i.LINK is not re-encoded but recorded directly to disc, with aligning the beginning of the DV stream with the logical sector boundary, as shown in Fig. 3.1.4.2.2(a).

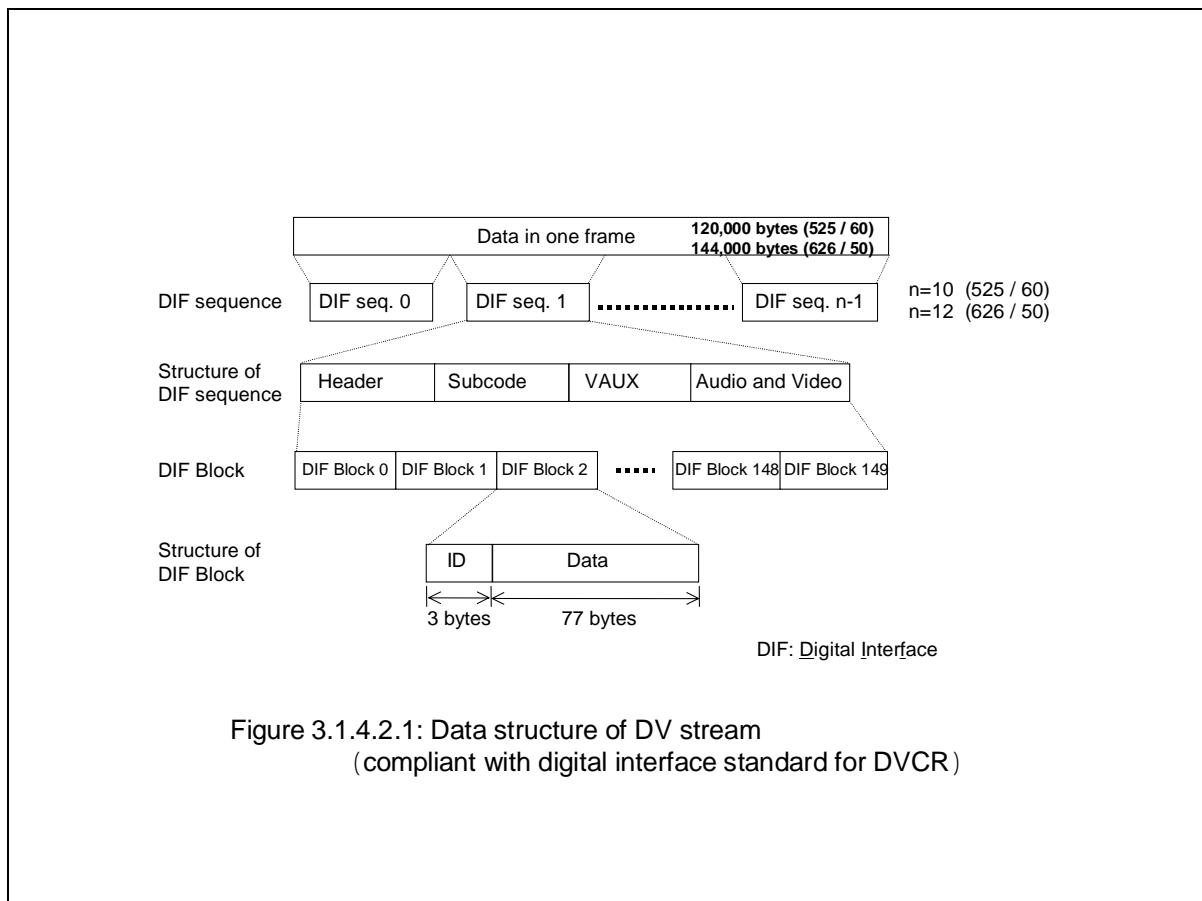

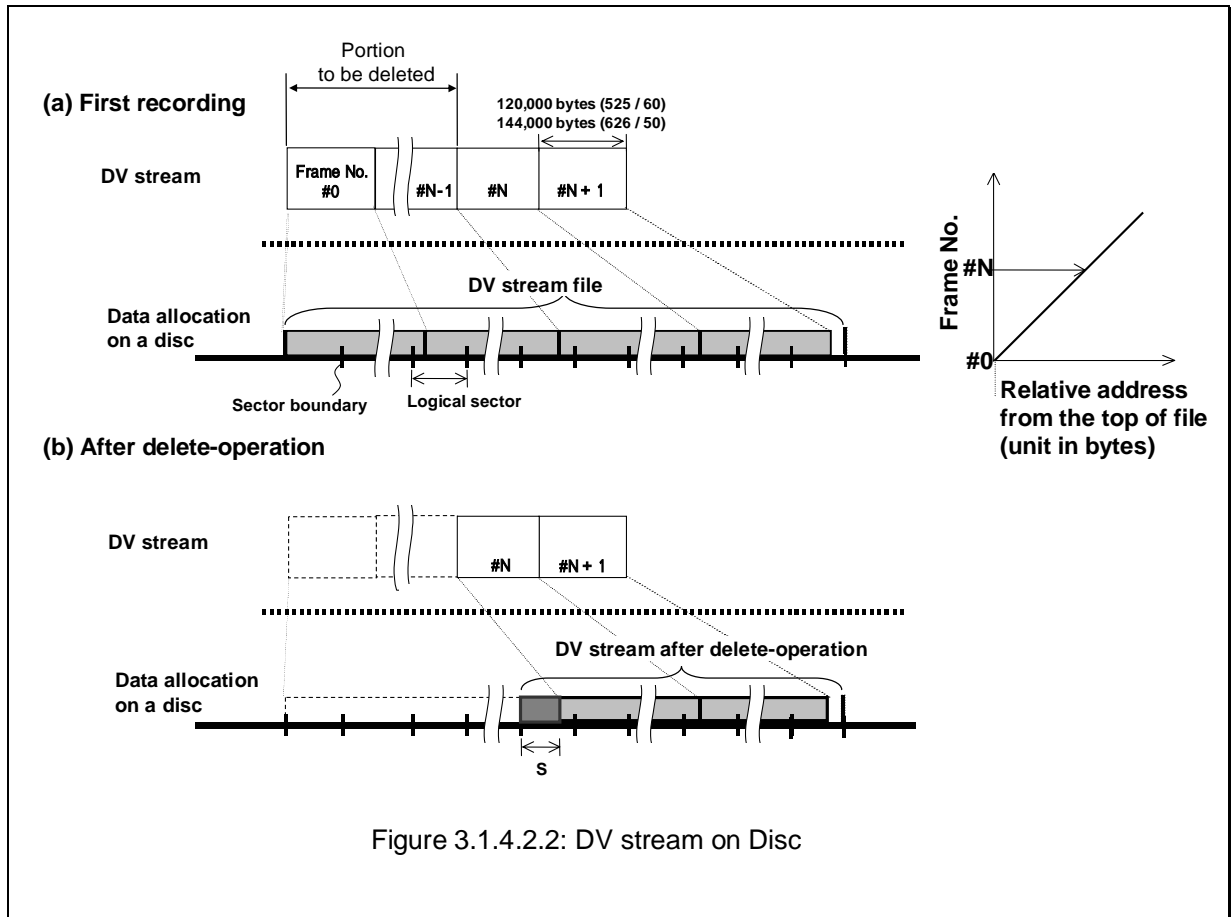

Also, as well as MPEG-2 TS recording, a Clip information file in which DV stream property information is stored is created for each stream file. Since the DV stream and MPEG-2 transport stream have different structures, a Clip information file that provides basic information for random access is defined for DV stream. In this way, differences in stream structure are absorbed by the Clip information file so that the PlayList as a top-layer of DV and MPEG-2 TS uses the same data structure.

Fig. 3.1.4.2.3 shows the directory and file structures. DV stream files are stored in the /BDAV/STREAM directory as are TS files. DV stream files have the extension "dvsd" and are accordingly distinguished from TS files. Clip information files and PlayLists are stored in the same directories as for TS files, BDAV/CLIPINF and /BDAV/PLAYLIST respectively.

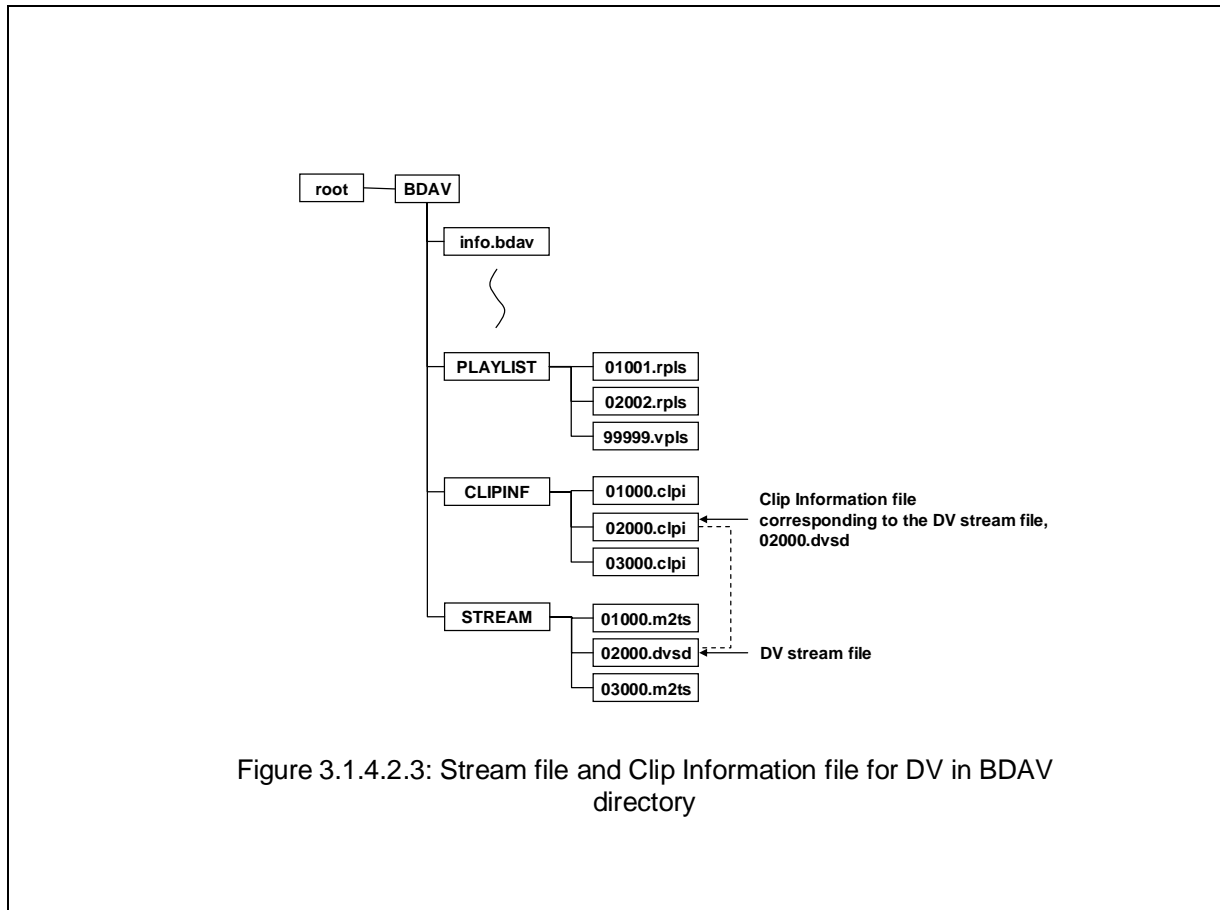

3.1.4.3 Random Access Method

Since the video compression method adopted by the DV format is intraframe coding, each frame in the DV stream has a fixed number of bytes (525/60:120,000byte, 625/50:144,000byte). Therefore, the addresses of the frame data corresponding to the playback start and end times specified in the PlayList can be obtained using a simple calculation.

As shown in Fig. 3.1.4.2.2(a), the frame numbers counted from the beginning of the file and their relative addresses are proportional to each other and this relationship can be used to easily obtain the relative address of a random access point.

This is why with the Clip information file for a DV stream there is no need to create a table (CPI) for random access such as EP_map or TU_map (see 3.1.5), which are required for MPEG-2 TS recording.

With linear editing, there may be cases where part of the DV stream file is removed (for instance, frames #0 to #N-1 in Fig. 3.1.4.2.2(a)). Because files are managed in logical sector units by the file system, after part of the file is removed, the beginning of the first frame will be offset from the beginning of new file, as indicated by the dark shade in Fig. 3.1.4.2.2(b). In this case, offset information S and the new top frame number #N are recorded in the Clip information file so that there is no need to shift stream data or add changes to the PlayList.

3.1.4.4 Minimum Extent Size

In general, the minimum extent size for recording needs to be defined in order to achieve seamless recording and playback. Because the DV stream has a comparatively high transfer rate of 28.8Mbps, the minimum extent size must be sufficiently large. The BD-RE Application Format provides for two minimum

extent sizes according to stream rate so that streams with a lower transfer rate than the DV stream can be recorded in an efficient manner. Defining the minimum extent size in this way makes seamless playback possible.

If part of a stream is removed, as described above, the stream may end up with sections that do not meet the conditions for contiguous recording required for seamless playback. However, even in this case, seamless playback can be achieved after part of the DV stream is removed by using the bridge sequence described later.

3.1.5 User Interface

Fig. 3.1.5.1 shows a conceptual diagram of stream management under the BD-RE Application Format. Stream management consists of two main layers, the PlayList layer and the Clip layer. The PlayList is a unit that represents a grouping of video/audio data to the user. For instance, a sequence of video/audio data from recording start to end constitutes a single PlayList and PlayList construction information is recorded as a single PlayList file. Only the PlayList layer can be seen from the user.

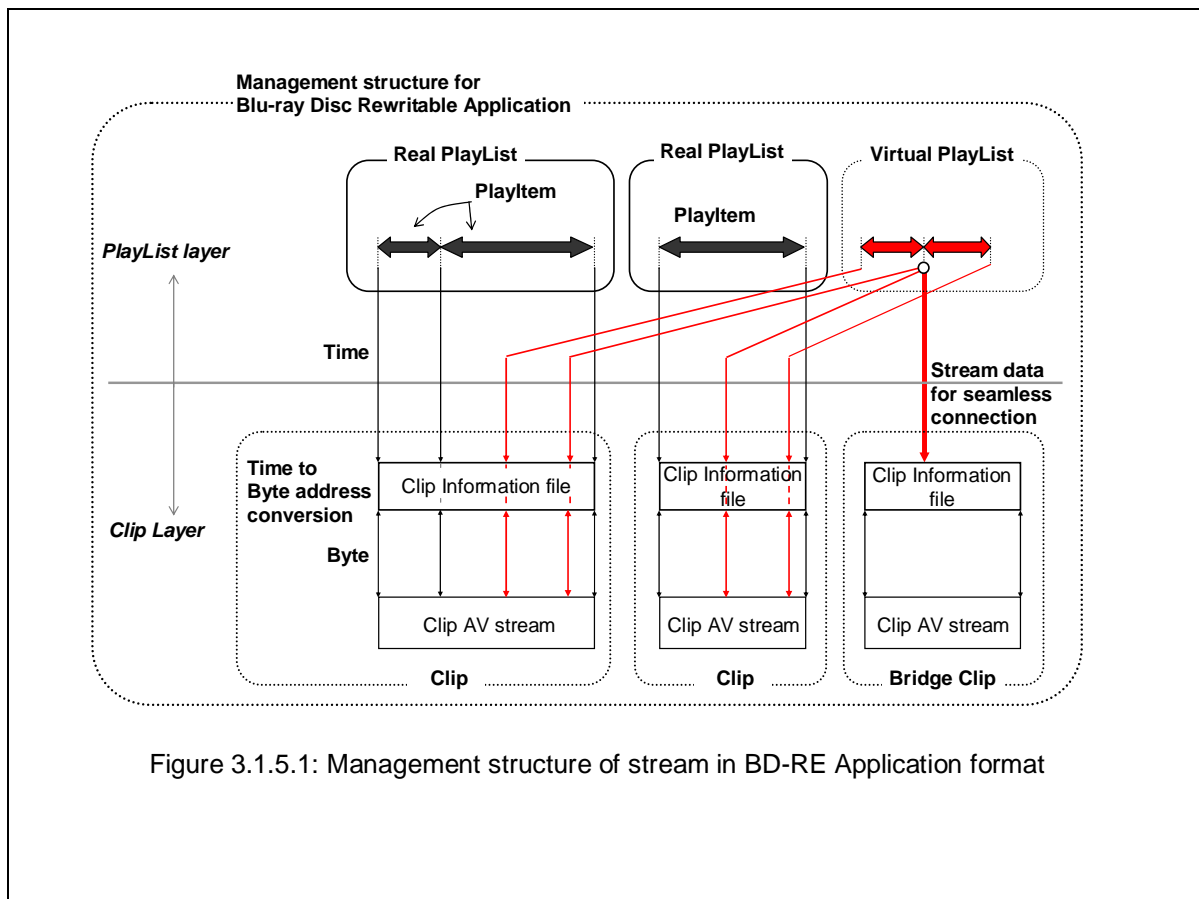

Figure 3.1.5.1: Management structure of stream in BD-RE Application format

The layer below the PlayList layer is the Clip layer which manages AV stream files. The Clip layer consists of AV stream files which store actual video/audio stream data and Clip information files that correspond one to one with Clip AV streams.

The Clip information file is composed of database which contains the information of non-contiguous STC points and program information regarding MPEG-2 TS, and stream's characteristic point information (CPI), and so on. The CPI is entry point information and is used to achieve high-speed random access and variable-speed playback.

First, the BD-RE Application Format assumed streams to be variable bit-rate MPEG video and defined an EP_map (Fig. 3.1.5.2) to store the byte positions in the file from which decoding can be started, such as

the beginning of a GOP. From this table, which defines the relationship between pts and the source packet numbers representing byte positions in the file, the address within the file for a specific time can be known immediately even for VBR (Variable Bit Rate) encoded streams. The BD-RE Application Format also defined a TU_map (Fig. 3.1.5.3) for recording transport streams other than MPEG video.

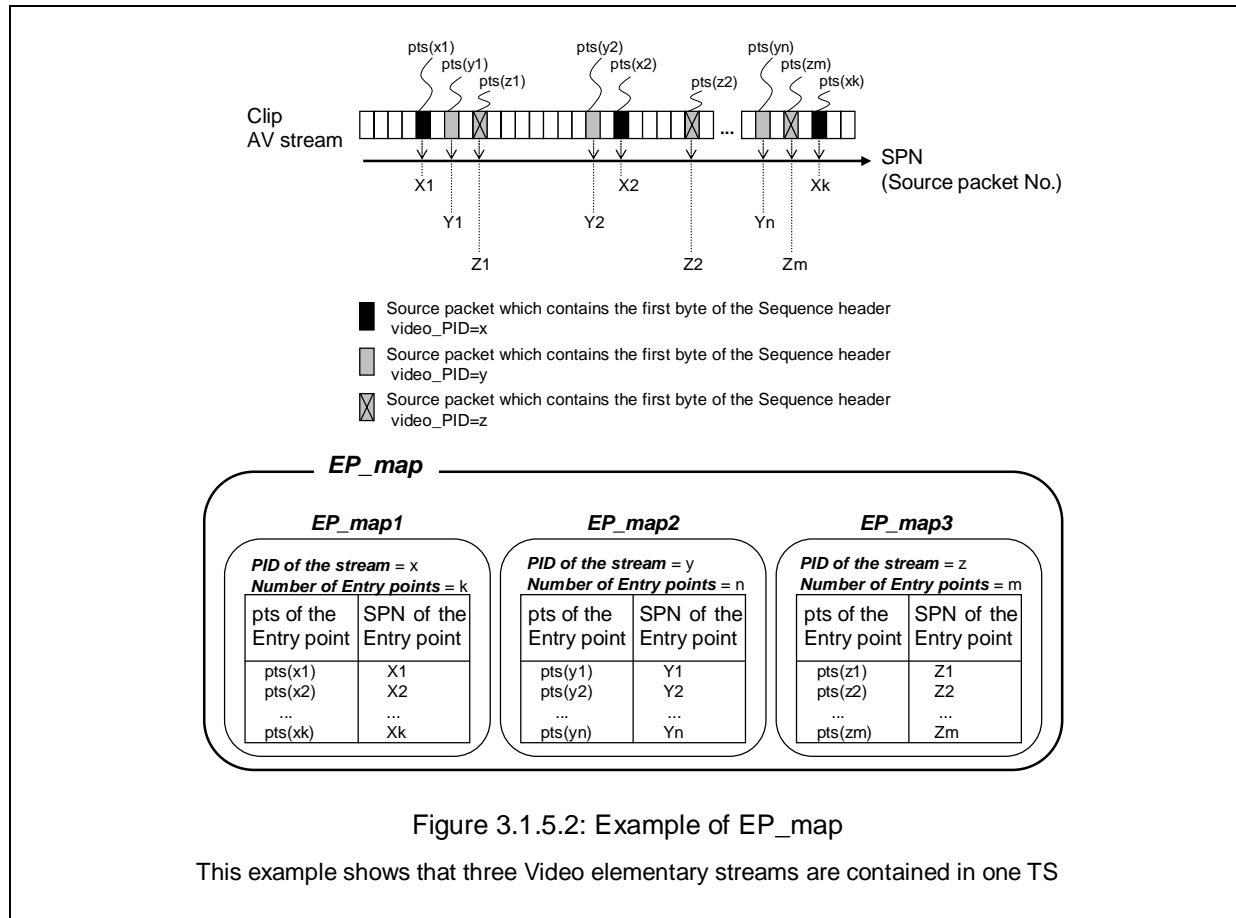

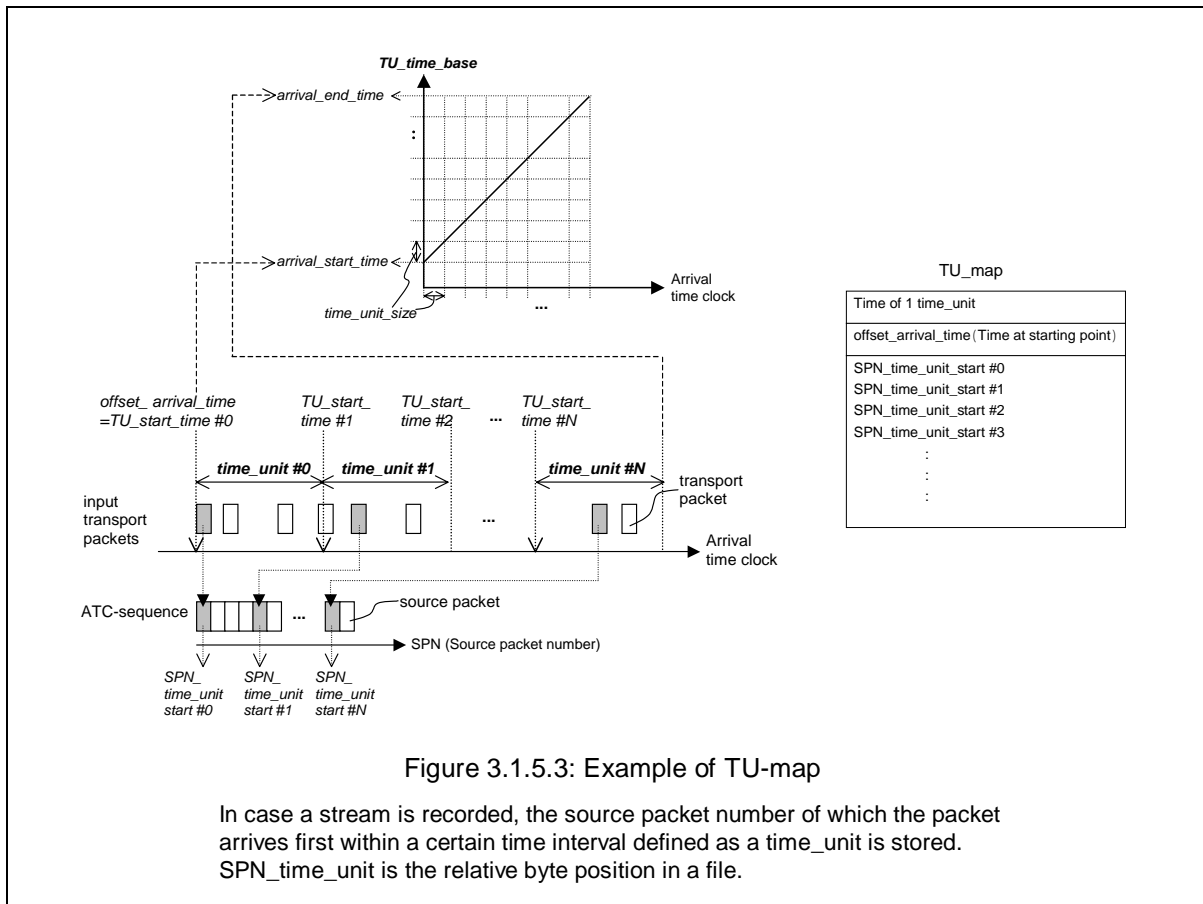

When the TU_map is used, time access is performed in units of time_unit and becomes less precise; however, random access operation of arbitrary transport streams becomes possible. The EP_map together with the TU_map are called CPI. These databases are created by the recorder when it records the stream.

The PlayList is a sequence of play-items. A play-item is a set of IN, OUT points that represent the playback time range within a Clip. PlayLists are created automatically whenever a new recording is made; these PlayLists are called real PlayLists. "Real" indicates that the PlayList is created one to one with a Clip at the same time as the Clip is recorded.

PlayLists can be generated by editing operations in addition to when new recordings are made. One method of editing is to add a change such as divide, combine, or delete (Fig. 3.1.5.4 to an existing PlayList. Editing may result in many-to-many relations between real PlayLists and Clips but the valid part of the clip is always referenced by a real PlayList. Deleting a real PlayList means the Clips which the PlayList refers to are also erased from the disc.

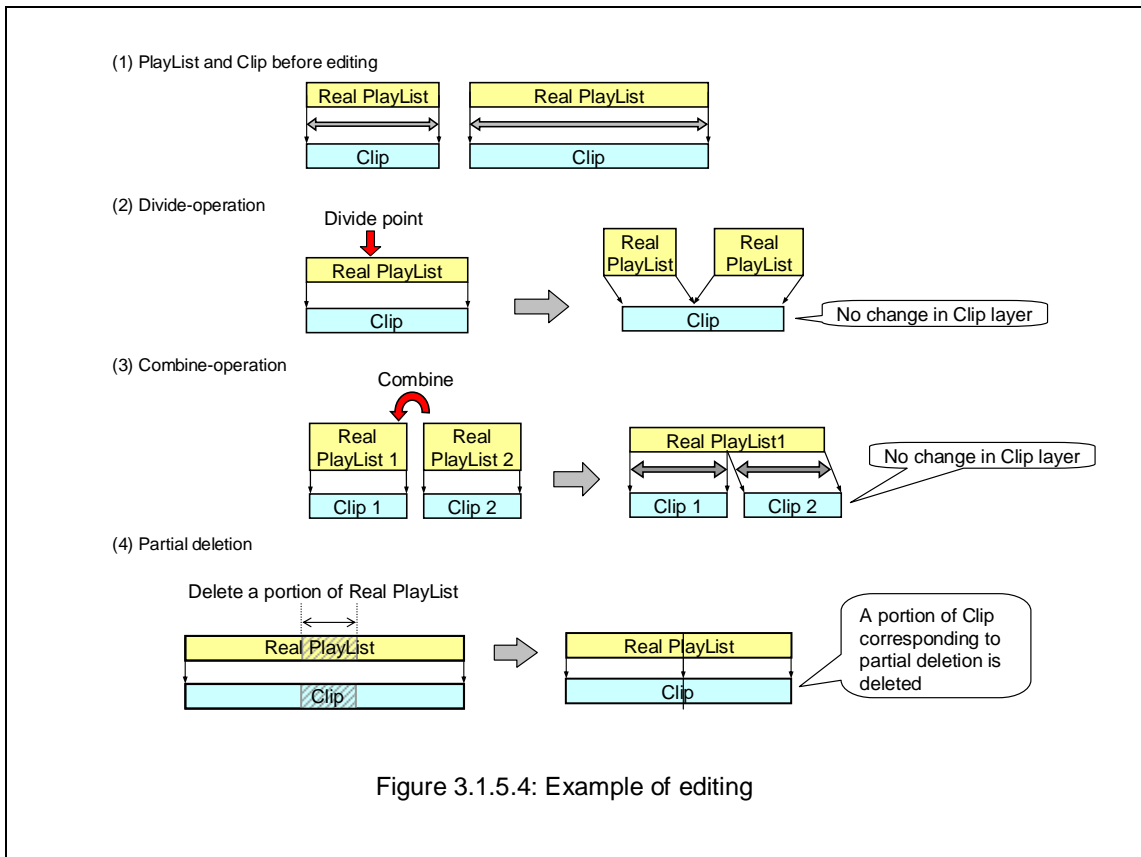

There is also the option of creating a new PlayList without altering an existing PlayList. Under the BD-RE Application Format, this is referred to as creating a virtual PlayList (Fig. 3.1.5.5).

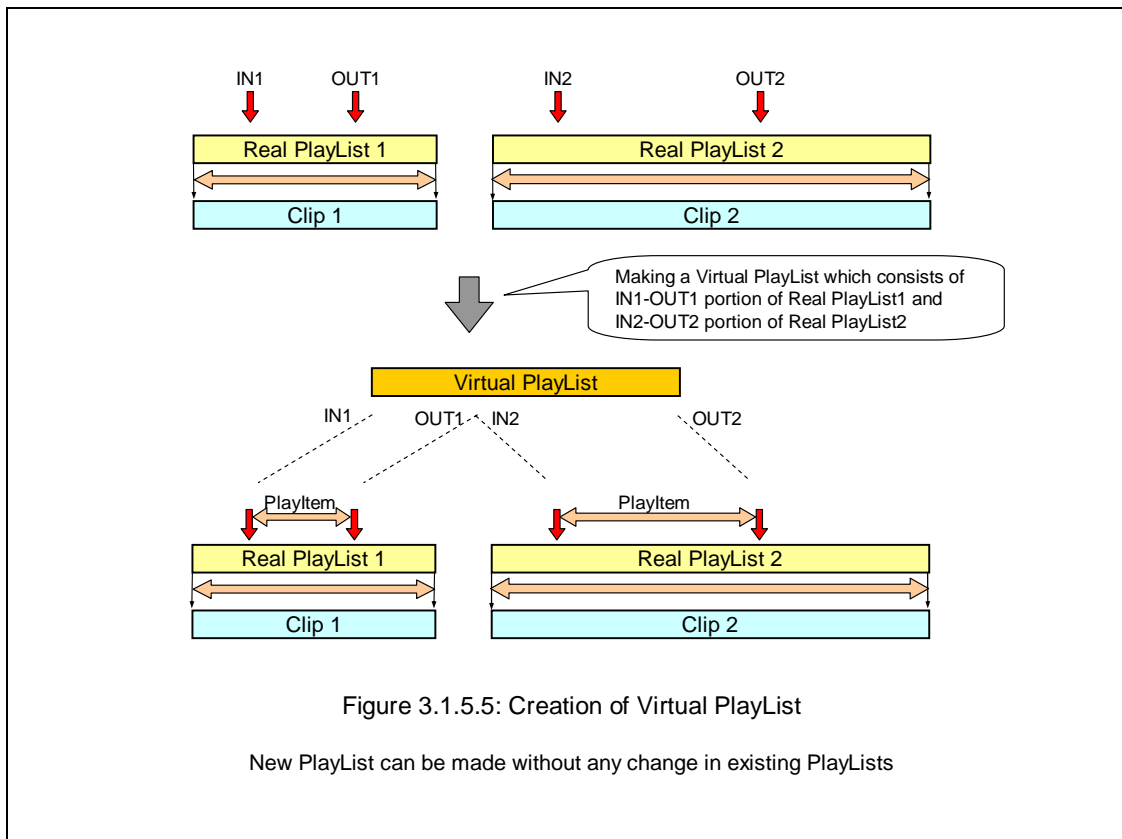

The virtual PlayList is a sequence of play-items that reference parts of other PlayLists; bridge sequences, described later, are used to achieve seamless playback even with non-destructive editing.

The BD-RE Application Format provides many other functions to improve ease-of-operation, such as thumbnails, marks, write protection, and playback-lock of individual discs using passwords.

Thumbnails are small still images and represent directory and PlayList contents in a visual manner. Under the BD-RE Application Format, thumbnails can be set to represent the entire recorded contents under the BDAV directory and also individual PlayLists.

A mark is the generic term for an index point that the user sets on the playback timeline to enhance ease-of-operation. Standard marks provided are bookmarks used for locating specific scenes, skip marks for skipping certain intervals during playback and resume marks for resuming playback from the scene where playback was previously stopped. Manufacturers can also add their own mark functions.

Fig. 3.1.5.6 shows the directory/file structure of the BD-RE Application Format where AV streams and databases are stored.

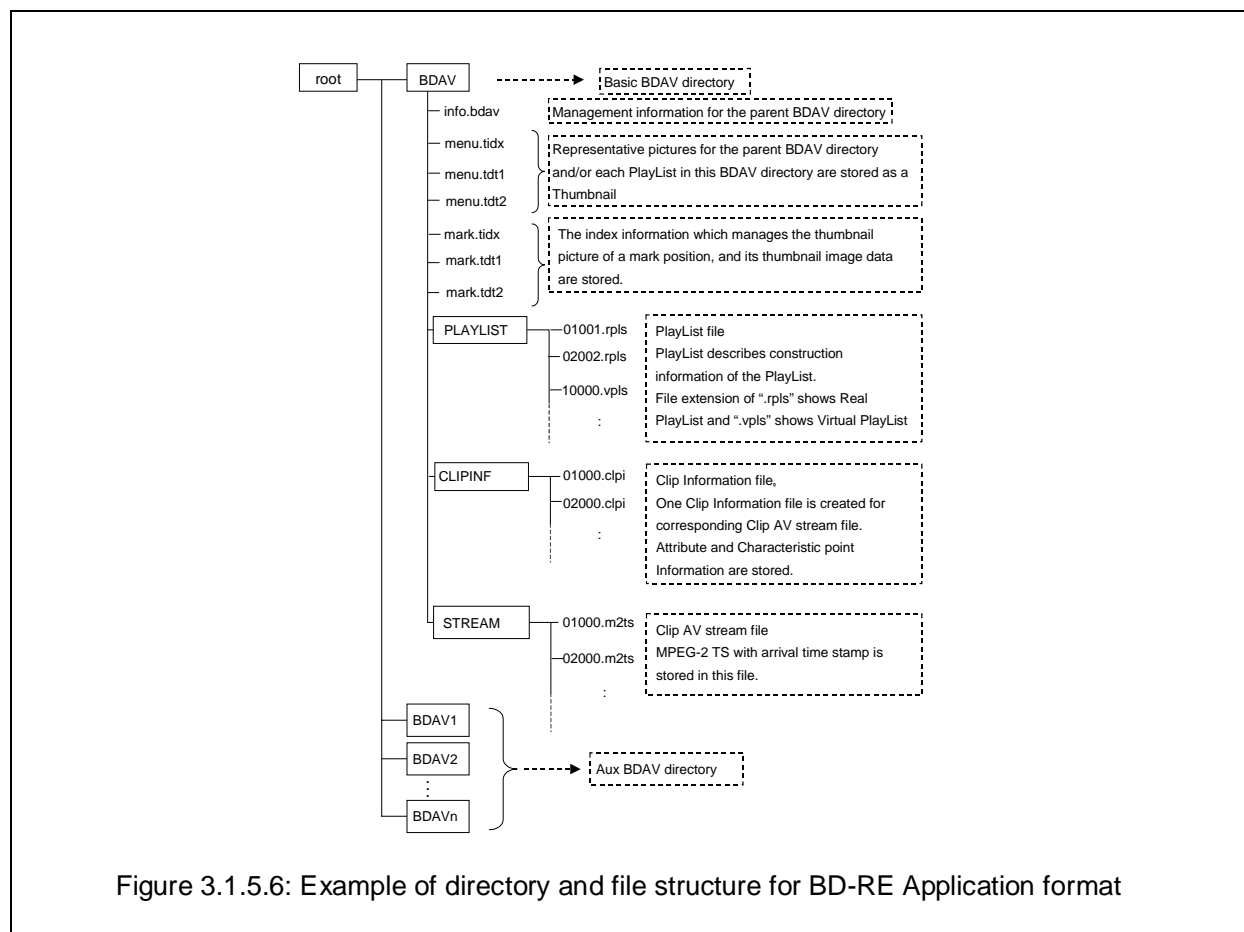

Figure 3.1.5.6: Example of directory and file structure for BD-RE Application format

3.1.6 Editing

3.1.6.1 Seamless Connection Editing

It is very important for a recording system to have easy-to-use editing functions that enable users to save wanted sections and cut out unwanted scenes from recorded contents (titles). The BD-RE Application Format realizes such editing functions through the virtual PlayList. For instance, by using the virtual PlayList, the user can select highlight scenes from different titles recorded on disc to create (edit) a new

title of highlight scenes and organize/save the new title on disc (Fig. 3.1.5.1, Fig. 3.1.5.5).

As previously described, the BD-RE Application Format adopts MPEG2 and DV formats as its video recording format (recording codec). When MPEG2 is used for recording, each frame image of the content is coded into either of three types—I-picture, P-picture, or B-picture—and compressed and recorded. To give a brief description of the characteristics of the three compressed image types: I-picture is an image that is coded using only its own data information (intraframe coded picture), P-picture is an image that is coded based on a prediction of the preceding I-picture or P-picture (interframe forward-direction predictive coded picture) and B-picture is an image that is coded by processing the I-picture and P-picture first and then being inserted in between (bi-directional predictive coded picture). If, as shown in the figure, two scenes are selected from different titles (that is, separate contents that were recorded at different times) and connected or two scenes separated in time are selected from the same single recording and connected to create a new title, simply gathering the Clip AV streams and decoding the streams in succession will cause a break in the MPEG2 compression pattern at the connection point (editing point) and, as a result, image frames will not be displayed contiguously. In other words, to display images contiguously even across the point where edited scenes are connected, the data needs to be restructured. The BD-RE Application Format specifies a structure (mechanism) called a bridge sequence to secure physical contiguosity and ensure contiguous playback across the editing point. Bridge sequences are managed by the virtual Playlist which is a logical mechanism. A brief description is provided below of the concept of the bridge sequence based on Fig. 3.1.6.1.1.

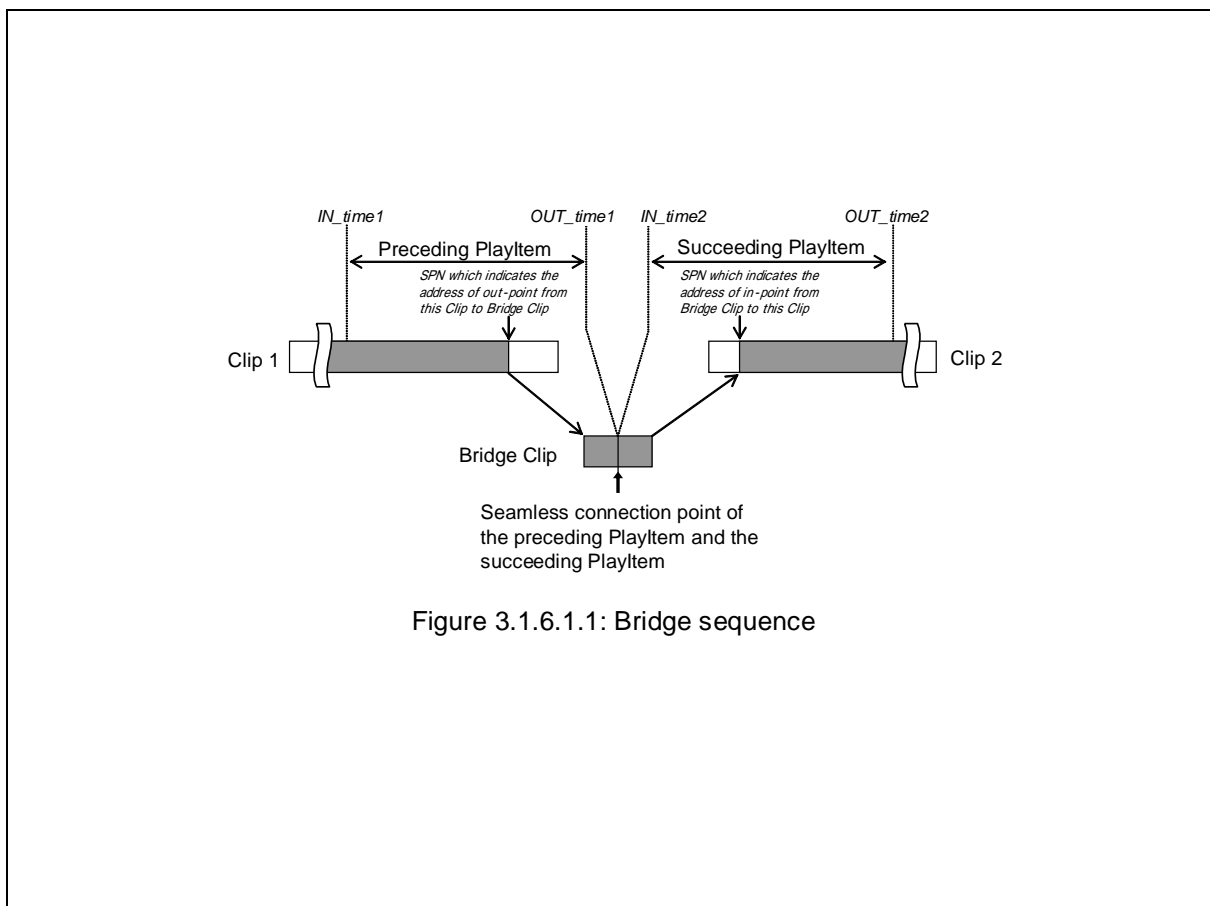
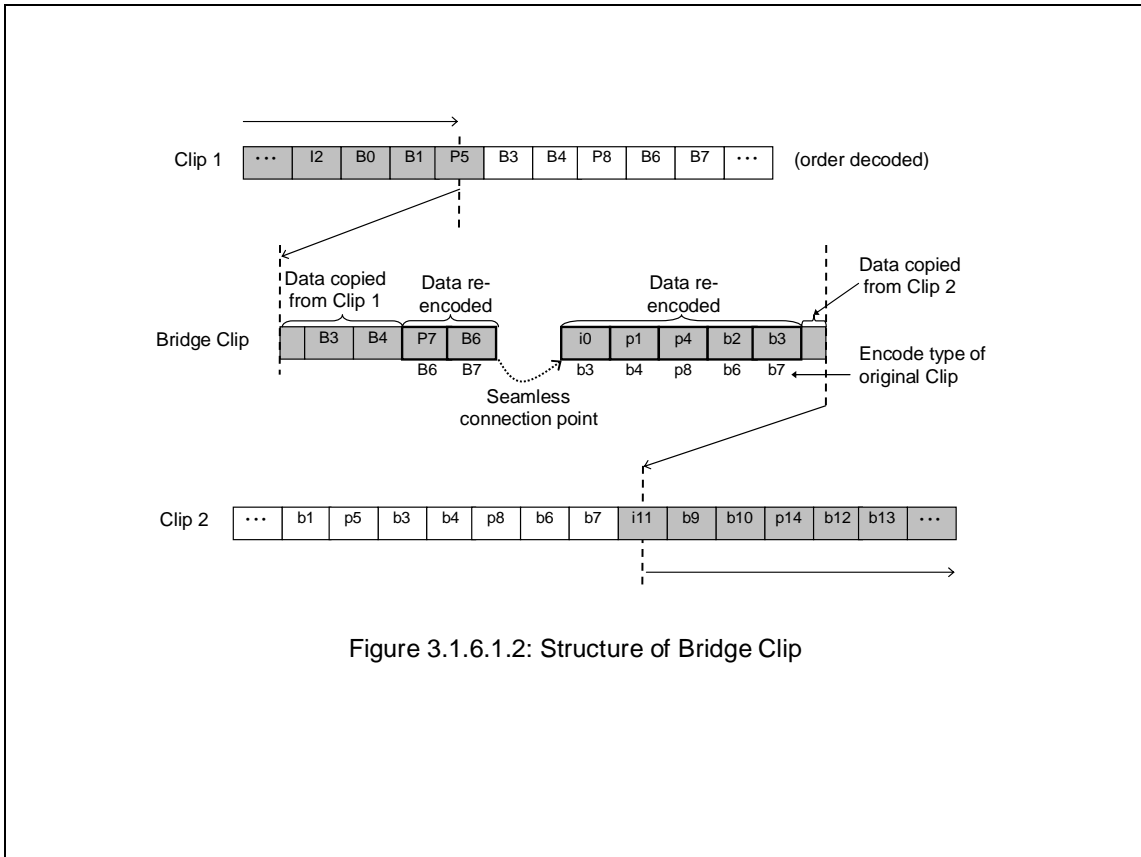
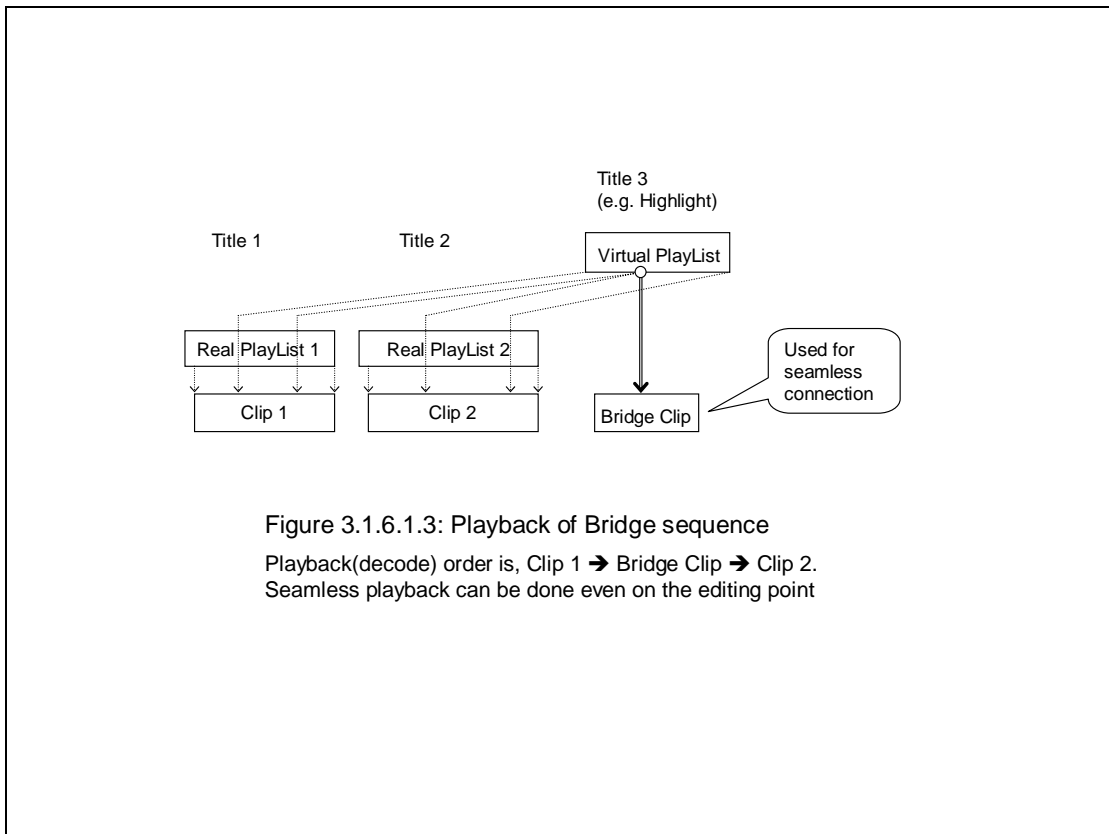

Figure 3.1.6.1.1: Bridge sequence

The bridge sequence reconstructs only the required parts as shown in Fig. 3.1.6.1.2 and is designed to keep data processing of editing points by the recorder to a minimum.



During playback, data is decoded in order of Clip 1 → Bridge Clip → Clip 2 as shown in Fig. 3.1.6.1.3 to ensure contiguous playback across the editing point.



3.1.6.2 Audio Dubbing

In general, when recording contents under the BD-RE Application Format, a set of video and audio data is multiplexed in the transport stream and is recorded as a single Clip. (This transport stream is called the main-path.) For instance, this mechanism is used for time-shift recording of broadcast programs.

An important editing function that enhances the recording system is audio dubbing, which allows the user to easily add other audio data to content after it is recorded. The BD-RE Application Format realizes an audio dubbing function by providing a mechanism called the sub-path. The sub-path is a structure that enables the user to select a separate stream during playback of a Clip on the main-path and play back the stream simultaneously with data on the main-path or by itself. For instance, this functionality can be used with content on which audio dubbing was performed to play back the audio data on the main-path and the audio data of a separate Clip on the sub-path at the same time or singly. Fig. 3.1.6.2.1 shows the relation between the main-path and the sub-path.

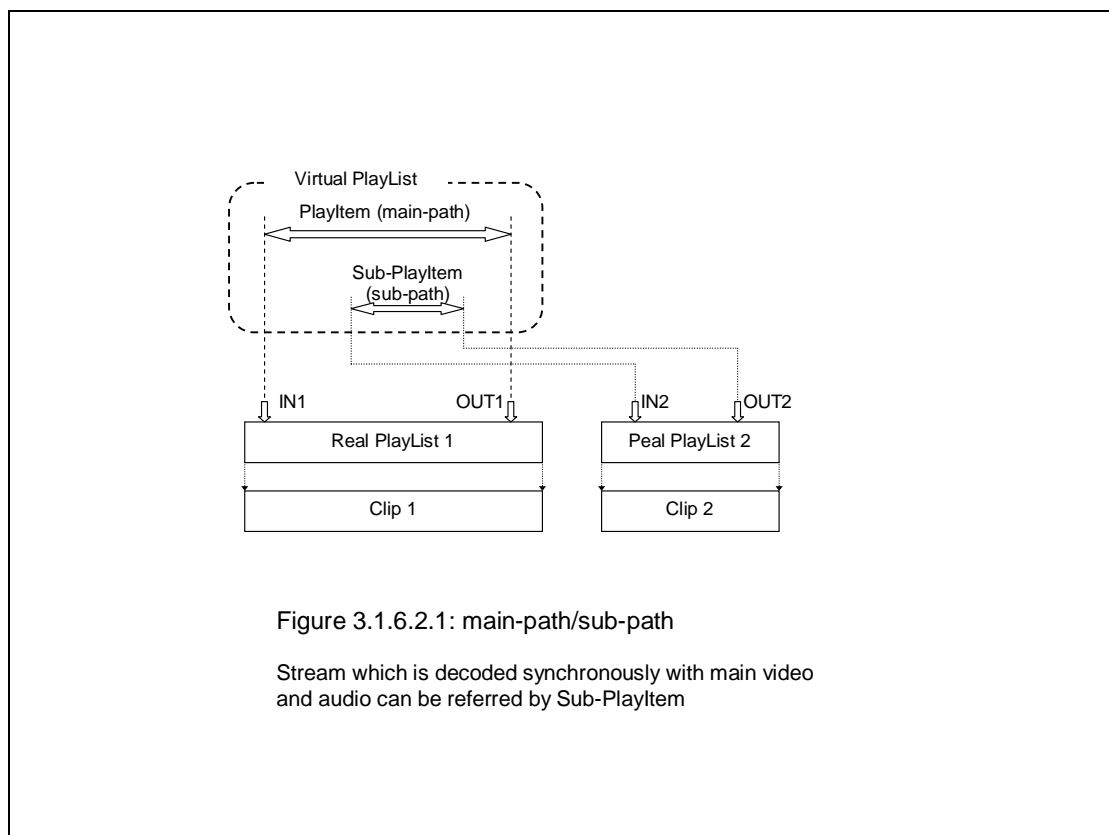

As shown in the figure, a sub-play-item is logically added to the play-item in the virtual Playlist to associate a separate Clip (sub-path) to the play-item on the main-path. The playback start time of the sub-play-item can be associated with the playback time (pts) of the play-item on the main-path. The recorder determines differences (such as the PCR value) in the timelines of the Clips on the main-path and the sub-path during playback and commences decoding.

3.1.7 Blu-ray Disc File System (BDFS)

3.1.7.1 A File System Suited to Video/Audio Stream Recording

The purpose of the file system is to manage/execute the data allocation on disc of video/audio streams

and the databases that manage those streams. The file system manages the recording area on the disc in units of logical sectors and provides read/write functions from/to disc for applications. Streams and databases are recorded as files to disc by the file system. There are huge differences in file sizes, with stream files exceeding one gigabyte in size while database files that manage the streams ranging from only a few kilobytes to a few megabytes. Also, the stream file is used only during actual video/audio playback when a certain amount of data must be read reliably from the file within a certain length of time, while the database file is used often such as during menu display when multiple files need to be read/written rapidly and frequently.

	Stream file	Database file
File size	Large (MB to GB)	Small (KB to MB)
Frequency of Read/Write	little	many
Timing of Read/Write	Real-time Read/Write is necessary	Real-time Read/Write is not mandated
Action to error	The influence of an error is local. Real-time is more important than error retry procedure even when error occurs	Error retry procedure and duplex writing are important because occurrence of error may cause a serious obstacle
Management in BDFS	File is stored into real-time data area Reference player mode	File is stored into Gathered file area Duplex writing by the robust attribute

Table 3.1.7.1.1: Difference between stream file and database file

The BDFS separates the recording area on disc into the gathered file area and the real-time data area as shown in Fig. 3.1.7.1.1 and records the file system’s management information and the application layer’s database files together in the gathered file area and other video/audio stream files in the real-time data area. This means that the files recorded in the gathered file area can be read with a fewer number of seeks and the response time during PlayList editing and menu display is shortened and, as a result, the response of the system is greatly improved.

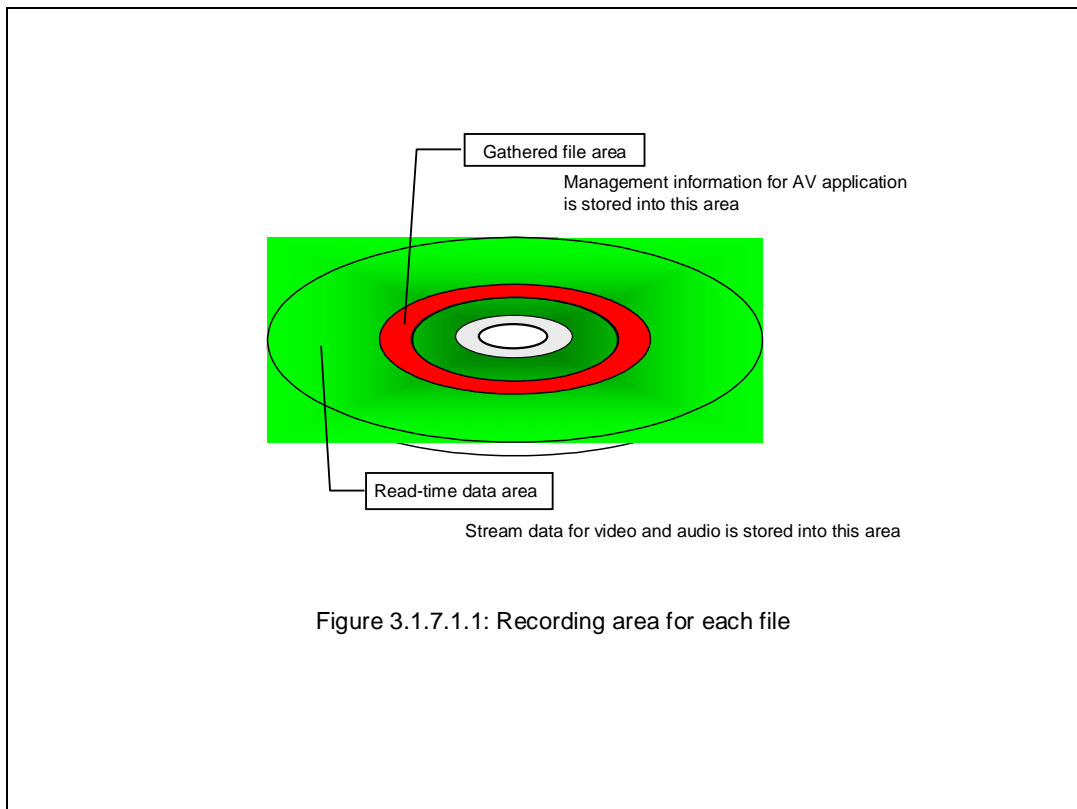

Figure 3.1.7.1.1: Recording area for each file

The cyclability of the disc depends on the physical properties of the media and is a sufficiently large value as long as the disc is used normally. However, with a recording system that frequently rewrites only a particular area the disc may have a shorter life. For instance, with a recording system that constantly uses empty areas beginning with the inner perimeter, the recording surfaces of the inner perimeter may have a shorter life than the outer perimeter. BDFS solves this problem by using a system which uses the free spaces on the disc with equal frequency.

3.1.7.2 Continuous Data Supply by Extents

When recording, delete or edit operations are performed repeatedly, small areas of empty space will occur all over the disc. These small areas are used to record a new file and this results in a single file composed of small groups of data that are scattered all over the disc. A group of data in such a file that is recorded on contiguous logical sectors is called an extent under the BDFS (Fig. 3.1.7.2.1). When a single file is made up of several extents, the file is read by jumping from one extent to the next and reading the extents in succession. However, when jumping from one extent to another, the disc rotation speed needs to be changed and the optical pickup needs to be moved. Data cannot be retrieved during this interval although the decoding/playback of video/audio data will continue without interruption. So to prevent any breaks occurring during playback, a mechanism is required to absorb the effects of the access intervals that occur between extents.

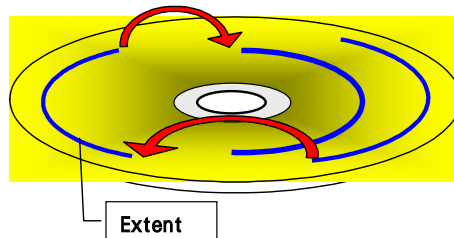
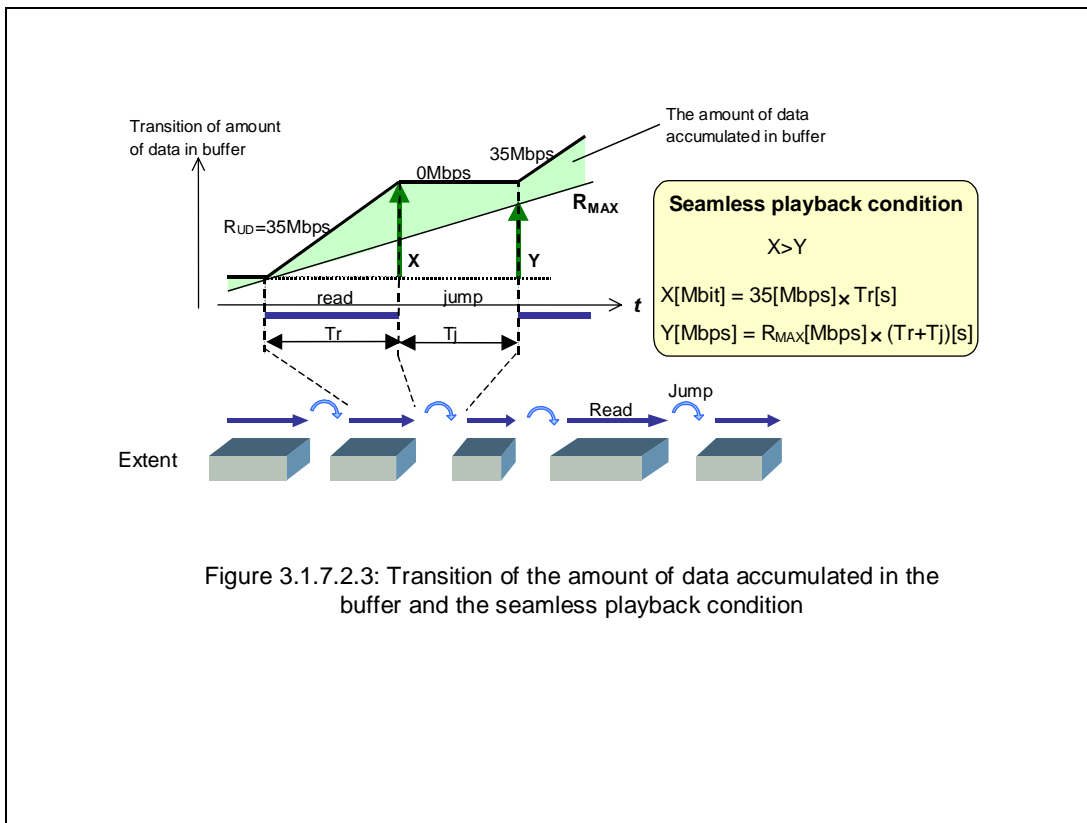
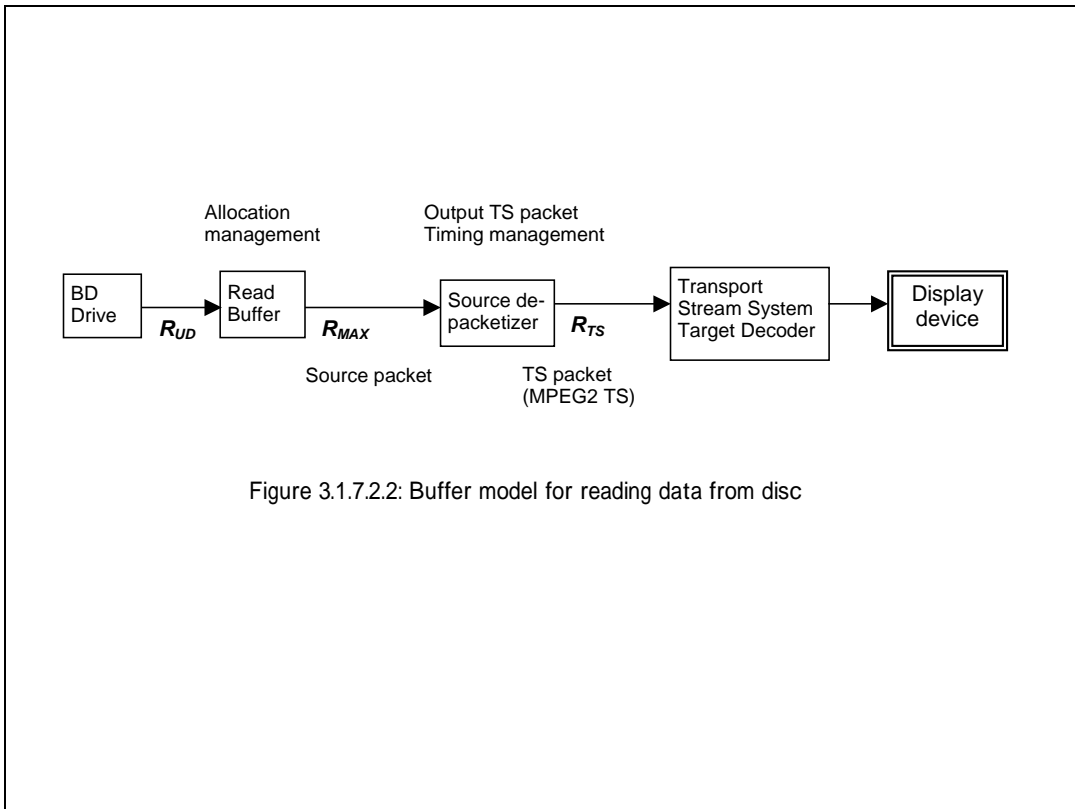

Figure 3.1.7.2.1: Extent

To prevent the interruption in video/audio playback when reading data from disc, the buffer memory must not be emptied of data before readout from the next extent becomes possible. This is the condition for continuous supply that is met for seamless playback (Fig. 3.1.7.2.2, Fig. 3.1.7.2.3). The minimum extent size is defined by the BDFS so that the buffer does not become empty when jumping from one

extent to another on the disc. A restriction is placed on the minimum extent size to allow for a sufficient amount of data to be accumulated in the buffer before the next extent is accessed.



3.1.8 Copy Protection System (CPS)

Digital broadcasting transmits a content's copy control information together with its video/audio data. In general, contents that are broadcast as pay-TV have the restriction information "copy once." Pay-per-view (PPV) contents may have the restriction "copy never." BD-RE recorders are required to operate appropriately in accordance with the copy control information.

Specifically, the BD-RE recorder records only contents that are labeled "copy once" or "copy free." When a content labeled "copy once" is recorded, the copy control information is changed to "copy no more" to prevent further copies being made and the copy control information is encrypted together with the content and recorded to disc. Furthermore, this content can only be outputted to the interface that is equipped with prescribed content protection technology so that copy control information is transmitted securely and managed correctly in the destination device.

BD-RE copyright protection has the following features:

- Optimized for the BD-RE AV format, which is an MPEG TS recording format
- Allows revocation of the device key to revoke invalid devices (adopts a revocation system)
- Encrypts content and its copyright control information before recording to disc
- Pre-records a unique value in the disc and uses that value for encryption (blocks bit-by-bit copy)

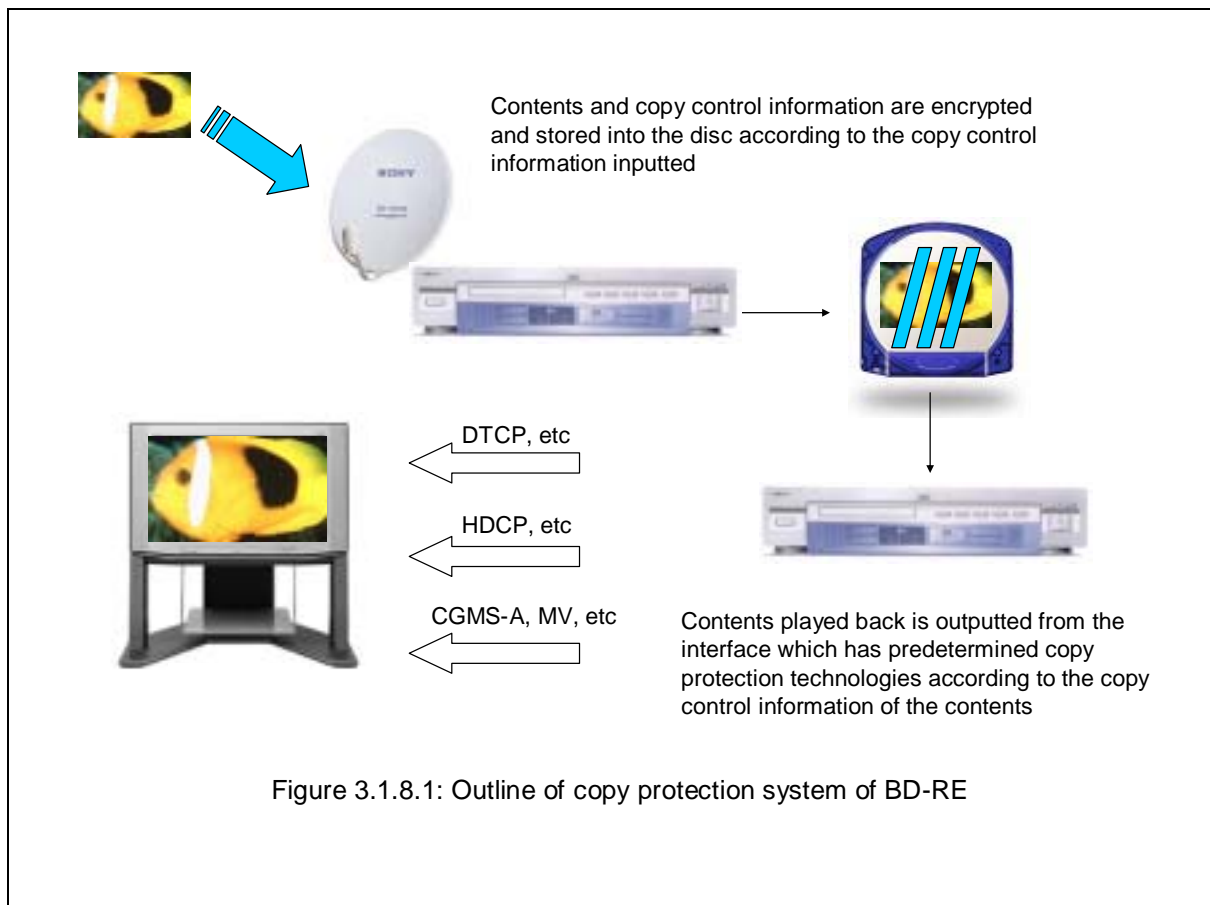

Figure 3.1.8.1: Outline of copy protection system of BD-RE

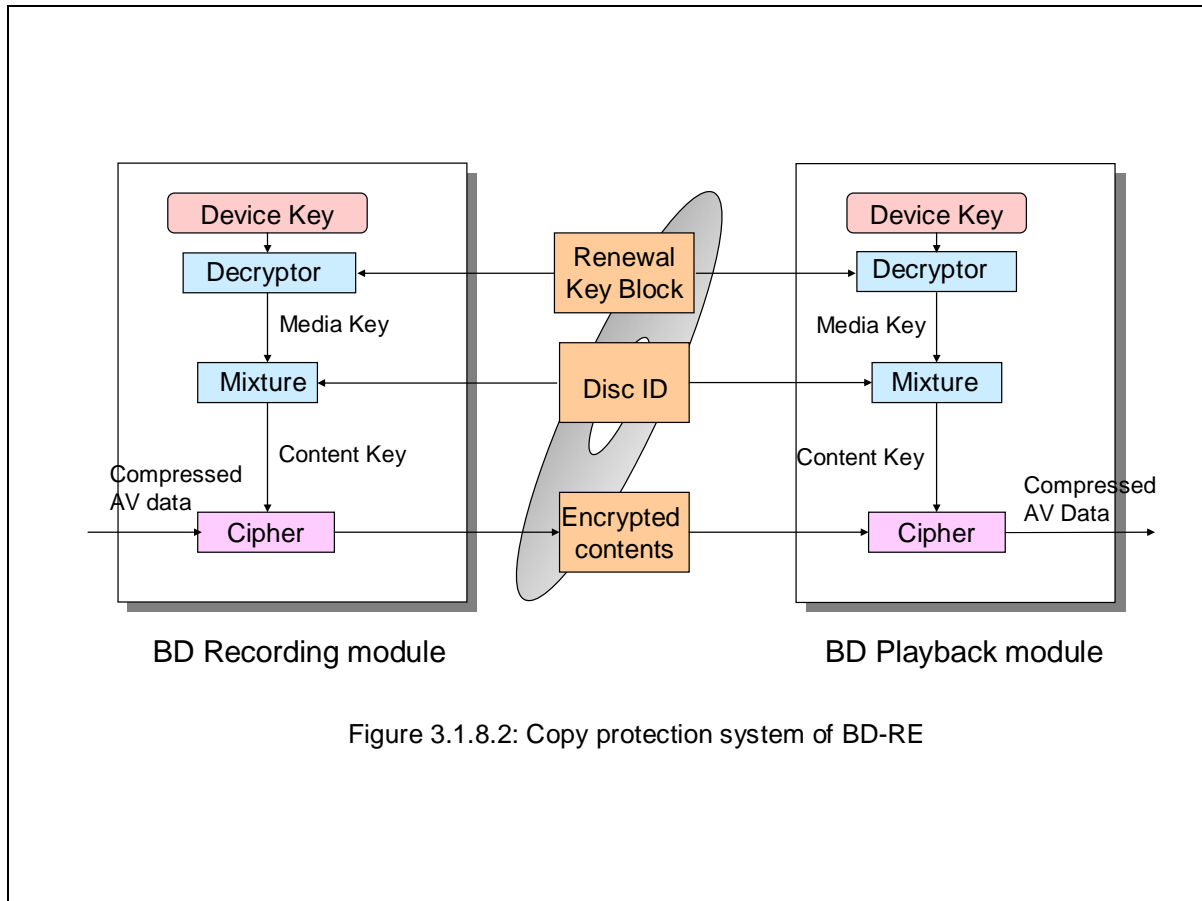

Figure 3.1.8.2: Copy protection system of BD-RE